

SmartBright Slim Panel

Kelly Cao/Allen Lin
Indoor Segment
Apr 2017



PHILIPS









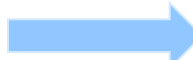

Contents

- Product Positioning
- Product Features and Benefits
- Product Design and Details
- Product Applications
- Product Designation
- Product Specifications
- Product Installation
- Product Photometry
- Sales Tool – Tender Specification Database
- Product Ordering Information

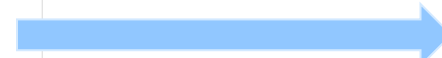
Office LED Recessed Category

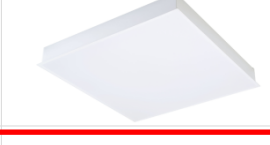
Application: Office, retail, healthcare

Key category attributes – Energy saving(CO₂ emission reduction), Visual Comfort

	Positioning	Photo	2014	2015	2016~2017
Statement	PowerBalance The first office norm complied LED solution at 100lm/W,		EF:120lm/W UGR:16 CRI:80 Driver: DALI	POE PowerBalance - 3100lm - UGR16 - 120lm/W - 50khrs	PowerBalance 3.0 - 3100lm/4000lm - 130lm/W - ACW - Modular flexibility
					
Performance	SmartPanel The most comfortable LED office lighting with affordable price		SmartPanel 2.0 EF:80m/W UGR:20 CRI:80 Lifetime:50K		SmartPanel 3.0 EF:95m/W UGR 19 available Lifetime:50K Slimmer design
	CoreView Indirect LED office lighting for inspiring office		CoreView 2.0 EF 80lm/W CRI: 80 Lifetime: 50K		CoreView 3.0 EF Typ. 100lm/W CRI: 80 Lifetime: 50K
	Coreline Troffer The most affordable LED specification office lighting		EF:90lm/W CRI:80 DALI Lifetime: 30~50K hrs	EF:100lm/W CRI: 80 DALI w. ACL Lifetime: 50K	Coreline 2.5 EF 105~110lm/W DALI w. ACL Lifetime: 50K
	SmartBright Panel The most cost-effective full window design delivering uniform light			EF >90lm/W CRI: >80 Lifetime: 25K	
Core	SmartBright Slim Panel Slim designed full window illumination with excellent cost effectiveness				SmartBright Slim Panel EF 80lm/W 2600lm/3600lm CRI: >80 Lifetime: 25K
	SmartBright Troffer Price competitive LED office to replace conv.lum		EF: >=80lm/W CRI: 80 Lifetime: 25K Price index vs conv.lum: 1.2		SmartBright Troffer G3 EF: 95lm/W Lifetime: 25K Price index vs conv.lum: 1.0

SmartBright Slim Panel – Features and Benefits



Features and benefits:

- System efficacy **80lm/W**, Energy saving 50% compared with TL troffer
- Recessed, suspended, **plaster ceiling (PCV)** - Multiple mounting to cater various applications
- **Slim** design – The height of luminaire **10mm**
- Full window illumination – deliver comfortable light with **excellent uniformity**
- **1 on 1 replacement over TL troffer** – The most affordable LED solution

Product Design & Details

Narrow Frame



600 x 600



Thickness : 10mm

Mounting accessory
(only PCV version related)



300 x 1200

Full Window illumination
Good lighting uniformity

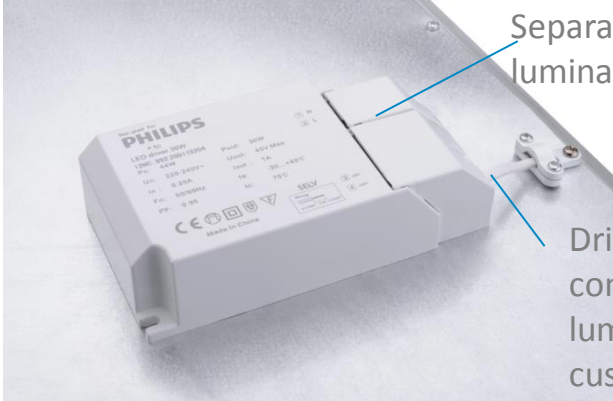

Separate driver on the luminaire back.

Driver to be connected to the luminaire by customer at site.

Product Applications – Wide Range

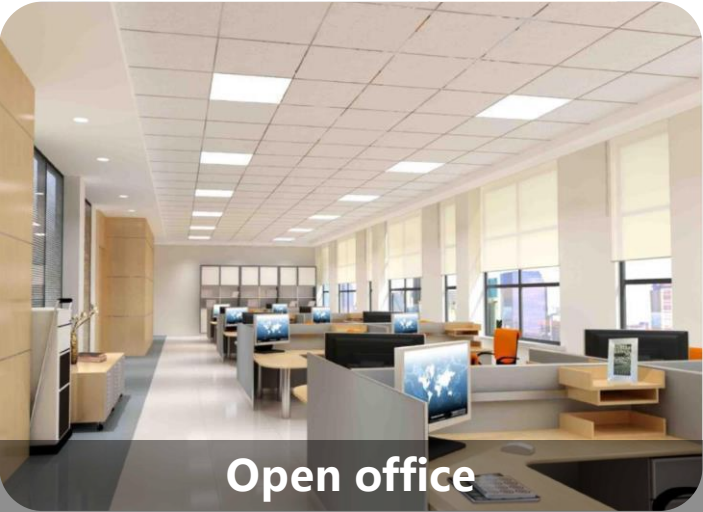

SmartBright Slim Panel

RC091V LED26S 840 W60L60 PCV GM

1 Lumen package

LED26S – 2600lm

LED36S – 3600lm

2 CCT

840 – 4000K

865 – 6500K

3 Dimension

W60L60 – 597 X 597mm

W30L120 – 297 X 1197mm

4 Mounting

– Recessed, suspended

PCV – Plaster ceiling



5 GM regular & CAU

GM - regular GM type



CAU – AU/NZ type w. Flex & plug



Technical Specifications – GM

Type	RC091V W60L60..GM	RC091V W30L120..GM
Picture		
System output	Typ. 2600lm, 3600lm	Typ. 2600lm, 3600lm
Wattage	34W, 45W	34W, 45W
System efficacy	Typ. 80lm/W	Typ. 80lm/W
CCT	NW(4000K), CW(6500K)	
CRI	> = 80	
SDCM	5	
Ambient temp.	25°C	
Operating temp.	-10°C ~ 35°C	
Input voltage	220-240V, 50/60Hz	
Driver	Fixed output	
Power factor	0.9	
Safety class	Class II	
IP rating	IP20	
Dimension(mm)	597x597 mm	297x1197 mm
Height(mm)	Luminaire: 10mm (without mounting accessories) Luminaire + driver: 41mm	
Installation	Recessed/Suspended, PCV	
Material	Metal housing with white painting, PS diffuser	
Lifetime	25,000 hrs @L70 B50	
Approbation	CB , EMC , CE, ASNZ	CB , EMC , CE, ASNZ

Technical Specifications – GC

Type	RC091V W60L60..GC	RC091V W30L120..GC
Picture		
System output	Typ. 2600lm	Typ. 2600lm
Wattage	34W	34W
System efficacy	Typ. 80lm/W	Typ. 80lm/W
CCT	NW(4000K), CW(6500K)	
CRI	> = 80	
SDCM	5	
Ambient temp.	25°C	
Operating temp.	-10°C ~ 35°C	
Input voltage	220-240V, 50/60Hz	
Driver	Fixed output	
Power factor	0.9	
Safety class	Class II	
IP rating	IP20	
Dimension(mm)	597x597 mm	297x1197 mm
Height(mm)	Luminaire: 10mm (without mounting accessories) Luminaire + driver: 41mm	
Installation	Recessed/Suspended, PCV	
Material	Metal housing with white painting, PS diffuser	
Lifetime	25,000 hrs @L70 B50	
Approbation	CCC, EMC	CCC, EMC

Product Installation

Recessed mounting

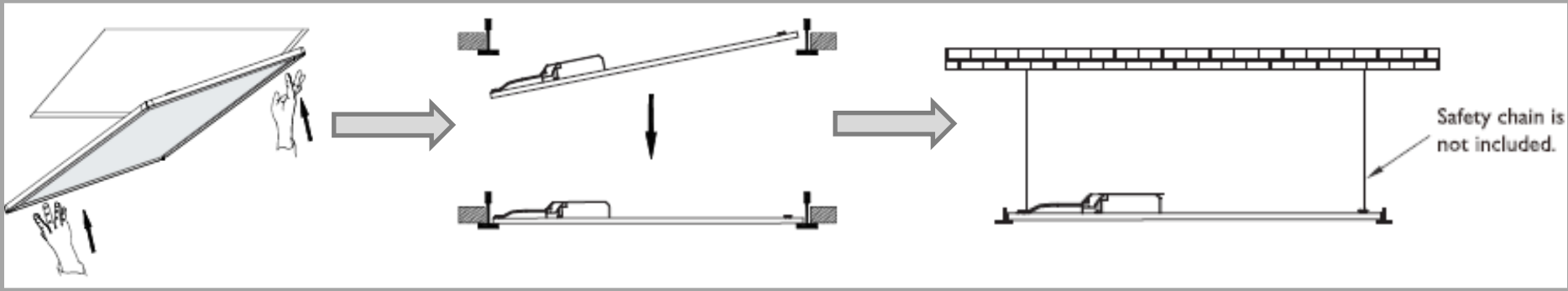

PCV mounting - Plaster ceiling

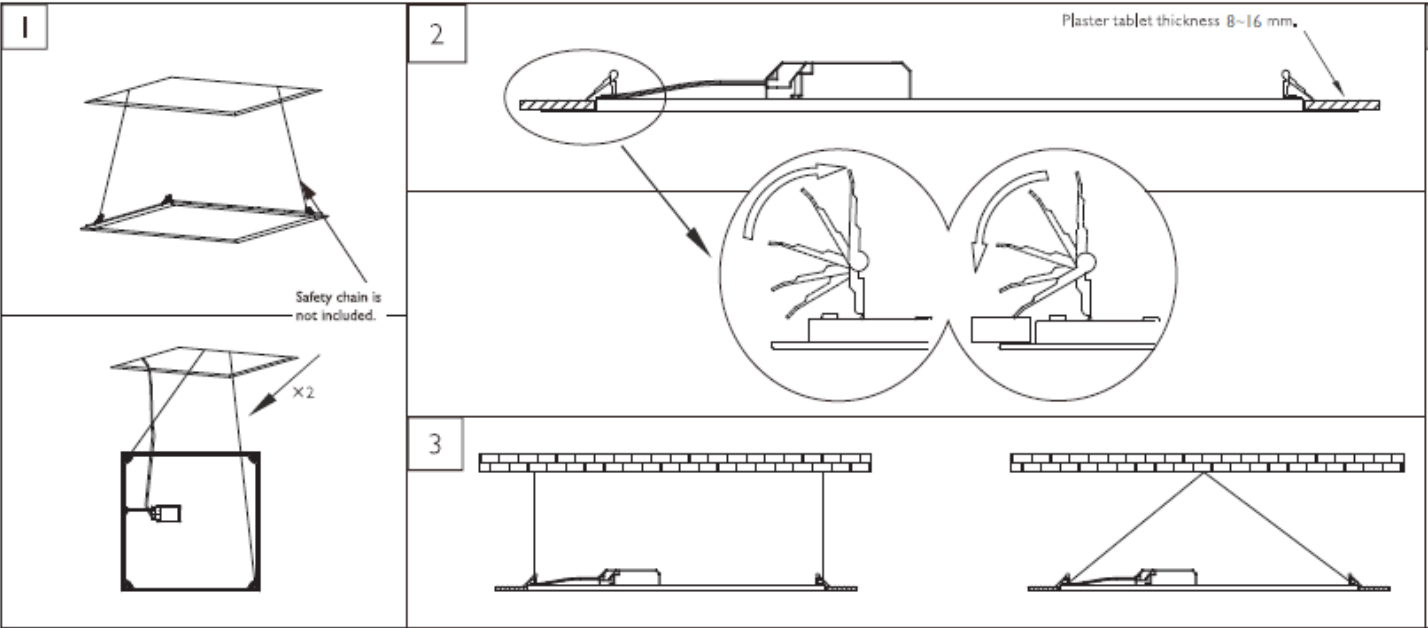

Product Photometry

RC091V LED26S...W60L60

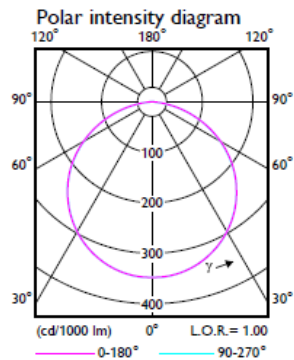

RC098V LED26S...W30L120

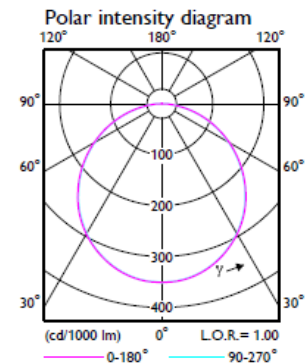

RC091V LED36S...W60L60

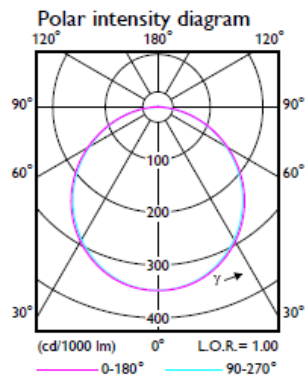

RC098V LED36S...W30L120

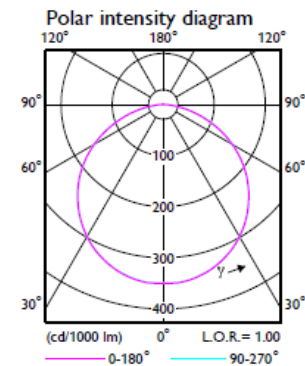

Sales Tool - Tender Specification Database

Country/Area	12acc	Description	Mounting	Wattage (W)	CCT (K)	Lumen Output (lm)	Lm / W	CRI	Ambient Temperature (C°)	IP Rating	Weight Kgs	Life hours@ L70	Control Gear	Voltage V	Frequency Hz	Operational Temperature	LED Driving Current (A)	Peak Current (A) @ 200V	Inrush Current (A)
GM	911401845637	RC091V LED26S/840 PSU w/60L60 GM	Recessed	34w	4000K	2600lm	80 lm/w	80	25	IP20	2.1Kg	25K	Fixed	220-240	50/60Hz	-10°35	760mA	160mA	8.1
GM	911401845797	RC091V LED26S/840 PSU w/30L120 GM	Recessed	34w	4000K	2600lm	80 lm/w	80	25	IP20	2.3Kg	25K	Fixed	220-240	50/60Hz	-10°35	760mA	160mA	8.1
GM	911401845897	RC091V LED36S/840 PSU w/60L60 GM	Recessed	45w	4000K	3600lm	80 lm/w	80	25	IP20	2.1Kg	25K	Fixed	220-240	50/60Hz	-10°35	1050mA	200mA	8.1
GM	911401845997	RC091V LED36S/840 PSU w/30L120 GM	Recessed	45w	4000K	3600lm	80 lm/w	80	25	IP20	2.3Kg	25K	Fixed	220-240	50/60Hz	-10°35	1050mA	200mA	8.1
GM	911401846097	RC091V LED26S/865 PSU w/60L60 GM	Recessed	34w	6500K	2600lm	80 lm/w	80	25	IP20	2.1Kg	25K	Fixed	220-240	50/60Hz	-10°35	760mA	160mA	8.1
GM	911401846197	RC091V LED26S/865 PSU w/30L120 GM	Recessed	34w	6500K	2600lm	80 lm/w	80	25	IP20	2.3Kg	25K	Fixed	220-240	50/60Hz	-10°35	760mA	160mA	8.1
GM	911401846297	RC091V LED36S/865 PSU w/60L60 GM	Recessed	45w	6500K	3600lm	80 lm/w	80	25	IP20	2.1Kg	25K	Fixed	220-240	50/60Hz	-10°35	1050mA	200mA	8.1
GM	911401846397	RC091V LED36S/865 PSU w/30L120 GM	Recessed	45w	6500K	3600lm	80 lm/w	80	25	IP20	2.3Kg	25K	Fixed	220-240	50/60Hz	-10°35	1050mA	200mA	8.1
GM	911401846497	RC091V LED26S/840 PSU w/60L60 PCV GM	Plastering ceiling	34w	4000K	2600lm	80 lm/w	80	25	IP20	2.1Kg	25K	Fixed	220-240	50/60Hz	-10°35	760mA	160mA	8.1
GM	911401846597	RC091V LED26S/840 PSU w/30L120 PCV GM	Plastering ceiling	34w	4000K	2600lm	80 lm/w	80	25	IP20	2.3Kg	25K	Fixed	220-240	50/60Hz	-10°35	760mA	160mA	8.1
GM	911401846697	RC091V LED36S/840 PSU w/60L60 PCV GM	Plastering ceiling	45w	4000K	3600lm	80 lm/w	80	25	IP20	2.1Kg	25K	Fixed	220-240	50/60Hz	-10°35	1050mA	200mA	8.1
GM	911401846797	RC091V LED36S/840 PSU w/30L120 PCV GM	Plastering ceiling	45w	4000K	3600lm	80 lm/w	80	25	IP20	2.3Kg	25K	Fixed	220-240	50/60Hz	-10°35	1050mA	200mA	8.1
GM	911401846897	RC091V LED26S/865 PSU w/60L60 PCV GM	Plastering ceiling	34w	6500K	2600lm	80 lm/w	80	25	IP20	2.1Kg	25K	Fixed	220-240	50/60Hz	-10°35	760mA	160mA	8.1
GM	911401846997	RC091V LED26S/865 PSU w/30L120 PCV GM	Plastering ceiling	34w	6500K	2600lm	80 lm/w	80	25	IP20	2.3Kg	25K	Fixed	220-240	50/60Hz	-10°35	760mA	160mA	8.1
GM	911401847097	RC091V LED36S/865 PSU w/60L60 PCV GM	Plastering ceiling	45w	6500K	3600lm	80 lm/w	80	25	IP20	2.1Kg	25K	Fixed	220-240	50/60Hz	-10°35	1050mA	200mA	8.1
GM	911401847197	RC091V LED36S/865 PSU w/30L120 PCV GM	Plastering ceiling	45w	6500K	3600lm	80 lm/w	80	25	IP20	2.3Kg	25K	Fixed	220-240	50/60Hz	-10°35	1050mA	200mA	8.1
GM	911401847297	RC091V LED26S/840 PSU w/60L60 CAU	Recessed with flex & plug	34w	4000K	2600lm	80 lm/w	80	25	IP20	2.1Kg	25K	Fixed	220-240	50/60Hz	-10°35	760mA	160mA	8.1
GM	911401847397	RC091V LED26S/840 PSU w/30L120 CAU	Recessed with flex & plug	34w	4000K	2600lm	80 lm/w	80	25	IP20	2.3Kg	25K	Fixed	220-240	50/60Hz	-10°35	760mA	160mA	8.1
GM	911401847497	RC091V LED36S/840 PSU w/60L60 CAU	Recessed with flex & plug	45w	4000K	3600lm	80 lm/w	80	25	IP20	2.1Kg	25K	Fixed	220-240	50/60Hz	-10°35	1050mA	200mA	8.1
GM	911401847597	RC091V LED36S/840 PSU w/30L120 CAU	Recessed with flex & plug	45w	4000K	3600lm	80 lm/w	80	25	IP20	2.3Kg	25K	Fixed	220-240	50/60Hz	-10°35	1050mA	200mA	8.1
GC	911401512741	RC091V LED26S/840 PSU w/60L60	Recessed	34w	4000K	2600lm	80 lm/w	80	25	IP20	2.1Kg	25K	Fixed	220-240	50/60Hz	-10°35	760mA	160mA	8.1
GC	911401512841	RC091V LED26S/840 PSU w/30L120	Recessed	34w	4000K	2600lm	80 lm/w	80	25	IP20	2.3Kg	25K	Fixed	220-240	50/60Hz	-10°35	760mA	160mA	8.1
GC	911401512941	RC091V LED26S/865 PSU w/60L60	Recessed	34w	6500K	2600lm	80 lm/w	80	25	IP20	2.1Kg	25K	Fixed	220-240	50/60Hz	-10°35	760mA	160mA	8.1
GC	911401513041	RC091V LED26S/865 PSU w/30L120	Recessed	34w	6500K	2600lm	80 lm/w	80	25	IP20	2.3Kg	25K	Fixed	220-240	50/60Hz	-10°35	760mA	160mA	8.1
GC	911401513141	RC091V LED26S/840 PSU w/60L60 PCV	Plastering ceiling	34w	4000K	2600lm	80 lm/w	80	25	IP20	2.1Kg	25K	Fixed	220-240	50/60Hz	-10°35	760mA	160mA	8.1
GC	911401513241	RC091V LED26S/840 PSU w/30L120 PCV	Plastering ceiling	34w	4000K	2600lm	80 lm/w	80	25	IP20	2.3Kg	25K	Fixed	220-240	50/60Hz	-10°35	760mA	160mA	8.1
GC	911401513341	RC091V LED26S/865 PSU w/60L60 PCV	Plastering ceiling	34w	6500K	2600lm	80 lm/w	80	25	IP20	2.1Kg	25K	Fixed	220-240	50/60Hz	-10°35	760mA	160mA	8.1
GC	911401513441	RC091V LED26S/865 PSU w/30L120 PCV	Plastering ceiling	34w	6500K	2600lm	80 lm/w	80	25	IP20	2.3Kg	25K	Fixed	220-240	50/60Hz	-10°35	760mA	160mA	8.1



Microsoft Excel
Worksheet

- Technical specification is provided by 12nc
- Database has been uploaded to the Connections Cloud

Product ordering information – GM & CAU

12NC	Description	Lumen	CCT	Dimension	Remarks
911401845697	RC091V LED26S/840 PSU W60L60 GM	2600lm	4000K	597 x 597mm	
911401845797	RC091V LED26S/840 PSU W30L120 GM	2600lm	4000K	297 x 1197mm	
911401845897	RC091V LED36S/840 PSU W60L60 GM	3600lm	4000K	597 x 597mm	
911401845997	RC091V LED36S/840 PSU W30L120 GM	3600lm	4000K	297 x 1197mm	
911401846097	RC091V LED26S/865 PSU W60L60 GM	2600lm	6500K	597 x 597mm	
911401846197	RC091V LED26S/865 PSU W30L120 GM	2600lm	6500K	297 x 1197mm	
911401846297	RC091V LED36S/865 PSU W60L60 GM	3600lm	6500K	597 x 597mm	
911401846397	RC091V LED36S/865 PSU W30L120 GM	3600lm	6500K	297 x 1197mm	
911401846497	RC091V LED26S/840 PSU W60L60 PCV GM	2600lm	4000K	597 x 597mm	Plaster ceiling
911401846597	RC091V LED26S/840 PSU W30L120 PCV GM	2600lm	4000K	297 x 1197mm	Plaster ceiling
911401846697	RC091V LED36S/840 PSU W60L60 PCV GM	3600lm	4000K	597 x 597mm	Plaster ceiling
911401846797	RC091V LED36S/840 PSU W30L120 PCV GM	3600lm	4000K	297 x 1197mm	Plaster ceiling
911401846897	RC091V LED26S/865 PSU W60L60 PCV GM	2600lm	6500K	597 x 597mm	Plaster ceiling
911401846997	RC091V LED26S/865 PSU W30L120 PCV GM	2600lm	6500K	297 x 1197mm	Plaster ceiling
911401847097	RC091V LED36S/865 PSU W60L60 PCV GM	3600lm	6500K	597 x 597mm	Plaster ceiling
911401847197	RC091V LED36S/865 PSU W30L120 PCV GM	3600lm	6500K	297 x 1197mm	Plaster ceiling
911401847297	RC091V LED26S/840 PSU W60L60 CAU	2600lm	4000K	597 x 597mm	Recessed with flex & plug
911401847397	RC091V LED26S/840 PSU W30L120 CAU	2600lm	4000K	297 x 1197mm	Recessed with flex & plug
911401847497	RC091V LED36S/840 PSU W60L60 CAU	3600lm	4000K	597 x 597mm	Recessed with flex & plug
911401847597	RC091V LED36S/840 PSU W30L120 CAU	3600lm	4000K	297 x 1197mm	Recessed with flex & plug

- MOQ=MPQ=4pcs

Product ordering information – GC

12NC	Description	Lumen	CCT	Dimension	Remarks
911401512741	RC091V LED26S/840 PSU W60L60	2600lm	4000K	597 x 597mm	
911401512841	RC091V LED26S/840 PSU W30L120	2600lm	4000K	297 x 1197mm	
911401512941	RC091V LED26S/865 PSU W60L60	2600lm	6500K	597 x 597mm	
911401513041	RC091V LED26S/865 PSU W30L120	2600lm	6500K	297 x 1197mm	
911401513141	RC091V LED26S/840 PSU W60L60 PCV	2600lm	4000K	597 x 597mm	Plaster ceiling
911401513241	RC091V LED26S/840 PSU W30L120 PCV	2600lm	4000K	297 x 1197mm	Plaster ceiling
911401513341	RC091V LED26S/865 PSU W60L60 PCV	2600lm	6500K	597 x 597mm	Plaster ceiling
911401513441	RC091V LED26S/865 PSU W30L120 PCV	2600lm	6500K	297 x 1197mm	Plaster ceiling

- MOQ=MPQ=4pcs



